

# OWNER'S MANUAL

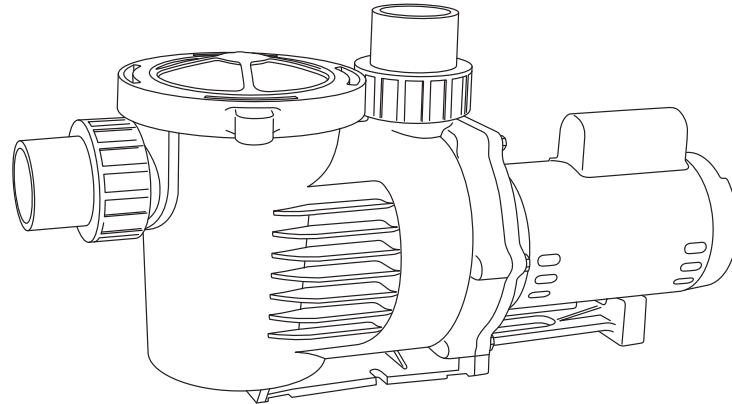

## **ArtesianPro** HIGH RPM PUMPS



PUMP MODEL: \_\_\_\_\_

SERIAL #: \_\_\_\_\_

DATE PURCHASED: \_\_\_\_\_

RETAIN THIS INFORMATION FOR FUTURE REFERENCE.

FOR QUESTIONS REGARDING INSTALLATION, OPERATION  
OR MAINTENANCE CALL (503) 356-5888

# ***PerformancePro***

PROUDLY BUILT IN THE USA SINCE 2000



## **PUMPS**

# Important Safety Instructions

Please read all instructions completely before installing or operating the pump.

Save this manual for future reference regarding installation, operation, maintenance and troubleshooting of this pump.

Please note the safety warning symbols as noted below:

	This warning symbol indicates the potential for personal injury or damage to the pump! Please be cautious!
	This symbol indicates a hazard which if not avoided could result in serious personal injury or death! Please be cautious!

Please carefully read and follow all safety instructions and procedures listed on the pump and in this manual.

 **WARNING**

**Pressure Hazard!**

Do not run your pump with discharge ports closed or blocked. Be sure to release system pressure before working on the pump.



 **WARNING**

**Electrical Hazard!**

Ground pump before connecting to power supply! Risk of shock, burn or death if not handled properly.



 **WARNING**

**Burn Hazard!**

Operating motor can be very hot. Do not touch motor while running. Allow to cool 30 minutes after shut down before handling. Risk of burn.



## GENERAL WARNINGS

1. This pump and motor unit should be installed by a qualified electrician or service person in accordance with all applicable state and local codes and ordinances, and in accordance with the National Electrical Code. Improper installation may create a mechanical or electrical hazard which could cause damage to property and could result in serious injury or death. 
2. In order to avoid serious injury or death, always disconnect power to the motor before servicing the pump and follow all instructions in this manual.
3. Always use the schematic on the motor for all electrical connections.
4. Never run the pump dry. The strainer pot must be filled with water and lid secured before starting the motor. The pump housing and entire suction line must be filled with water for proper operation prior to starting the pump. Running dry will void the warranty and can result in permanent damage to the pump unit.
5. To prevent incorrect motor rotation, install a ball or swing type check valve. Do not use spring check valves.
6. Maintain a minimum flow rate of at least two gallons per minute to avoid damage to the pump unit.
7. Visually inspect the pump and motor a minimum of once per week. If any leakage between the motor and pump housing is present, replace the mechanical seal. The seal faces wear similar to car tires and must be replaced periodically. For critical applications, replace the mechanical seal yearly. If pump is excessively noisy, shut it down and contact support.
8. For 3 phase motors, ensure proper rotation. See section 7 in electrical for details.
9. In freezing environments it is advisable to winterize your pump to prevent damage. Do not allow pump or system plumbing to freeze, as freezing can cause damage that may lead to equipment failure or possible injury and will void the warranty.

# Understanding priming and pump operation

## The Basics

Your pump is powered by an electric motor that directly affects your water flow rate. When the electric motor is turned on it utilizes centrifugal force to generate velocity of the water. The water then flows into the strainer pot from the water source, filtering out debris. Water continues its flow into the eye of the impeller where the water meets the impeller vanes and converts kinetic energy into static pressure allowing the pump to maintain pressure and is then forced out of the pumps discharge port resulting in continuous water flow for your waterscape oasis.

## The Prime

The Artesian Pro High RPM pump is considered a "true" self-priming pump. This means it is designed to prime and operate at varying heights up to 9 feet above the water source surface as well as varying horizontal lengths. It is important to note that operating at maximum suction lift height may negatively affect the pumps overall performance. If after starting the pump you notice it takes more than three minutes for water to start flowing into the priming pot after being filled with water and energized, it is recommended to install a rubber flapper type swing check valve. The valve should be as low and as close to your source water as possible to maintain constant pressure and shorten prime time. The best location can even be underwater when possible as this can provide an airtight fit even without PVC adhesive. Some swing check valves have true union connection fittings that offer easier access for cleaning when needed. Never use a spring loaded check valve as it will reduce or stop flow.

## With Valve

What to expect for priming cycle with swing check valve installed. Essentially, when utilizing a properly installed swing check valve the priming process is less time consuming and is more efficient. When installing a swing check valve, be sure your connections are properly seated and airtight. Then, simply fill the priming pot with water until the intake plumbing and priming pot are full. Replace the lid, securing tightly and turn on your pump. With the swing check valve in place your pump is fully primed from the beginning. However, if after running your pump you observe the water level in the strainer pot decreasing continuously, this indicates there is either a blockage limiting the flow or a union fitting, connection on the intake pipe or lid is not airtight. Check all connections for debris, crimping, or cracking and re-tighten or replace parts as needed.

## No Valve

What to expect for priming cycle without a swing check valve installed. In installation applications where the pump and plumbing are above the water level and no swing check valve is installed, the priming process will work as listed in the installation instructions on page 4. In this application the internal pressure in the pipe drops below outside barometric pressure which allows this pressure to slowly push water toward the pump. This slow push results in a longer priming cycle. It is important to note that the incoming water flow may initially be very little or non-existent for the first few minutes. If three minutes pass with no water flowing into the priming pot, the pump should be shut off, connections rechecked, water refilled and system restarted.

With a valve or without a valve, the time it takes for your pump to complete the prime cycle is based on a variety of factors including pipe type, diameter, suction lift height, horizontal distance, motor speed and horsepower. The entire cycle can range from one to fifteen minutes to complete; however, as noted above, you should see water flowing into the pump within three minutes or less.

For system specific assessments including suction lift and friction loss guidance and operating questions, please call 503-356-5888 or email [sales@performancepropumps.com](mailto:sales@performancepropumps.com).

## General

### Before Installation

Open the pump box when received and inspect for evidence of rough handling or damage to the pump and verify the product ordered. If damage is found, notify the freight carrier and contact the vendor purchased from immediately. For order discrepancies, contact the vendor purchased from immediately.

Be sure your installation location is no higher than 9 feet above the water surface level.

If using smaller than 3" pipe, excessive fittings such as elbows, sweeps or reducers, using an excessively long pipe run, using additional strainers or any other water flow restriction device, can increase the prime cycle time. Refer to the Pump Operation information on page 3.

Proper installation of your Artesian Pro pump will help ensure years of trouble free service.

1. Position the pump as near to the water and as low as is practical. This will help reduce priming time, avoid cavitation, and maximize your pumps performance.
2. Minimize friction loss by using the appropriate diameter pipe determined by gallons per minute flow, reducing run length, and minimizing the number of elbows and fittings as much as possible.
3. Maximize your pumps service life by protecting the motor from the elements by ensuring it is well covered and adequately ventilated. Exposing your pump to excessive heat or moisture will shorten the life of the motor.
4.  **WARNING** Protect the motor against dirt, water, and all foreign matter. If the motor has been flooded, do not operate it until it has been checked by an authorized motor technician and has been found to be safe to operate. If the motor is damaged by dirt, moisture, foreign matter or corrosion it is not covered by the warranty.
5. Mount the motor to a stable base where it will not get submerged. Use caution when installing in a vault. Be sure proper drainage is in place to prevent flooding. A sturdy pedestal under the pump is beneficial in a vault application to maximize space to the ground. Ensure the vault is properly ventilated.
6. The pump ports are 3" slip on both the inlet and discharge ports. The Artesian Pro series offers 2" or 3" fitting sizes. The fittings included with your pump should connect to PVC or flex pipe plumbing. All plumbing lines should be self supported and properly aligned. This will prevent undue stress to the housing and fittings. We recommend using a good primer and PVC cement to glue the pipe to the tailpiece fittings.
7. Installations in which the water level is elevated above the pump it is highly recommended to use a ball or swing type check valve to prevent back flow and possible reverse rotation. A ball valve will supplement a swing check valve and allow flow adjustments.
8. **FILL THE PRIMING POT WITH WATER BEFORE STARTING THE PUMP.**
9. When determining pump placement, it is important to consider the distance and height from the water source. To ensure reasonable prime time without an inline swing type check valve, position the pump no higher than 9 feet from the water source. Positioning is also important to maintain the pumps ability to stay primed and minimize cavitation. Do not use spring loaded check valves!

## Installation

1. After thorough inspection, carefully remove the pump from the box.
2. Secure the pump on a solid, flat foundation. A covered location is always best and care should be taken to ensure adequate ventilation. See installation tips for beneficial tips.
3. Install a ball or swing type check valve as needed to facilitate pump disconnection, flow control and servicing.
4. Connect plumbing to the pump by dry fit testing first to ensure proper fit and proper pipe alignment. Be sure the union nut is on the union tailpiece before gluing in place.
5. Once proper fit and alignment is established, use proper pipe sealant designed for plastic pipe. Support plumbing as needed to prevent strain and damage. Do not over tighten the nut included with the pump in the quick connect fittings. Hand tightening is sufficient.
6. Wiring of this pump should be in accordance with the wiring diagram located on the motor. Ensure the pump is wired for the correct supply voltage and is supplied by no smaller than 12 gauge wire. The circuit breaker should be a minimum of 20 amp but may vary. See page 6. It is recommended that wiring be performed by a licensed electrician. For 3 phase wiring, see section 7 under Electrical.
7. If your pump will be hardwired be sure to ground the motor correctly by connecting code compliant wiring to the green grounding screw located under the wiring plate.
8. When wiring is complete, double check intake and discharge fittings to ensure a snug fit. Note: There may be installations in which plumbing allows for trapped air in the system. If this happens, priming will be difficult. In this case, loosen the discharge fitting slightly to allow trapped air to bleed off. Once primed tighten the discharge fitting.
9. On flooded suction systems where the water source is higher than the pump, the pump will fill with water once the supply valve is opened. However, on both flooded and non-flooded systems it is recommended to open the strainer pot lid, fill with water, ensure the lid oring is clean of any debris and close the lid securely prior to starting.
10. Once priming pot is filled and supply valves (if present) are opened your pump is now ready to prime. Turn the motor on by plugging in the unit or switching on the power supply. Priming will vary in length. See page 3 for details. Water should continue to flow into the basket as the pump goes through the priming process. The priming process should not take longer than 15 minutes. The pump should never run dry. If water stops flowing into the strainer pot, shut the pump off immediately and see Troubleshooting Tips or Pump Operation pages for more information.

Note: At initial start up, the water level in the pump housing, as seen through the clear lid should drop rapidly and have a small amount of water entering the pump in less than three minutes. There is no need to be alarmed as this is normal. If no air leaks are present the small amount of water flow will continue to gradually increase resulting in a fully primed pump operating at maximum performance.

# Electrical

Before wiring any part of the motor be sure the power is disconnected.



It is recommended that wiring be performed by a licensed electrician or professional serviceperson. If pump has a factory preinstalled cord, wiring has already been set and this step is not needed; unless voltage change is required in which case the cord will need to be removed and steps followed below.

1. Inspect the motors internal wiring to ensure voltage supply is matched between the motor and the power source. If voltage does not match, it will damage the motor and void the warranty.  
Example: If connecting your pump to a 115V circuit, make sure the motor connections match the 115V wiring diagram listed on your particular motor.
2. Supply voltage must be within +/- 10% of nameplate voltage indicated on the motor. Incorrect voltage supply may result in fire or damaged motor and voids the warranty. If you are not certain, please consult with a licensed electrician.
3. Use designated supply wire size specified in the chart below. Correct wire size is necessary to avoid electrical insufficiencies, allowing the motor to run cooler, more efficiently and eliminating line voltage loss. It is important to connect your pump to a ground fault circuit interrupter (GFCI) for safety.
4. Wire motor following the connection diagram located on the motor. Note differences in high and low voltage arrangements. If a cord has been preinstalled the connection was completed at the factory.
5. Be sure all connections are clean and tight. Ensure the motor is properly grounded. Typically a green ground terminal is located inside the motor connection box. The ground wire must be properly connected to an electrical service ground to safely operate.
6. The pump must be connected to an adequately sized circuit. It is recommended to have a dedicated circuit that will prevent voltage drop from other loads as occurs on shared circuits.
7. When using 3 phase power the motor leads must be energized in the correct sequence to provide the correct motor rotation. When viewed from the back end (opposite drive end), the motor must rotate clockwise. Incorrect rotation could destroy the pump and void the warranty. If sequence of the incoming electrical supply lines is not known, briefly connect the power for a second or two to determine the rotation while looking at the fan through the motor end plate on the back end (opposite drive end) of the motor. If you are unable to see the fan you will need to remove the drip cover (solid plate) on the back end of the motor (opposite drive end) in order to see the motor shaft as this unit type will not have a visible fan. If the rotation is incorrect, exchange any two of the connected leads and retest.



- \* Risk of shock! Connect only to a ground fault circuit interrupter (GFCI). Contact an electrician if uncertain.
- \* Do not bury electrical cord unless using certified conduit. Locate the cord safely to minimize accidental damage.
- \* Replace damaged cords immediately to minimize risk of electric shock.
- \* Do not use extension cords to supply electricity to the pump.

RECOMMENDED WIRING AND CIRCUIT BREAKER DATA FOR ARTESIAN PRO HIGH RPM

CIRCUIT DATA			WIRING DATA					
HP	CIRCUIT	VOLTS/Hz/PH	WIRE GAUGE	WIRING SIZE PER AMPERAGE CAPACITY				
				25-50 ft	100 ft	150ft	200ft	250ft
1/2	15 Amp	115 or 230/60/1	16	13 amps	10 amps	*	*	*
3/4	20 Amp	115 or 230/60/1	14	15 amps	13 amps	7 amps	*	*
1	20 Amp	115 or 230/60/1	12	20 amps	15 amps	10 amps	8 amps	7 amps
1.5 or 2	30 Amp	115 or 230/60/1	10	30 amps	30 amps	20 amps	15 amps	15 amps
3 or 5	30 Amp	115 or 230/60/1						

\*Not recommended for use at this length. Note: The longer the wiring length the lower the amp conductivity due to voltage drop.

ELECTRICAL

## Maintenance

### Cleaning the basket:

The strainer basket in the priming pot should be inspected and cleaned at least one (1) time per week, more often if excessive debris is present in the operating environment.

1. Turn off your pump and disconnect from the electrical source by unplugging or turning off the breaker.
2. If you have a ball valve placed at the return side of your pump, be sure to close the valve to prevent backflow.
3. Remove the black clamp ring by holding the tabs and turning the clamp ring counter clockwise. Take care if the clamp ring is too tight. Slightly bumping the tabs may aid in releasing the grip. Remove the lid and clean out the basket. It is recommended to clean out the basket using a sprayer on a garden hose and a brush as needed. Do not hit the basket on any hard surface as this will weaken and damage the basket.
4. Reinstall the basket so that the tab under the basket locks in place.
5. Fill priming pot (basket section) with water.
6. Replace the lid securely.
7. Open ball valve (if present).
8. Connect power and start the pump.



If the pump has been running with no incoming water flow for more than three (3) minutes it is important to immediately turn the pump off by disconnecting the unit from the power supply. If the volute (main pump housing) is hot, allow the pump a minimum of one hour or more to cool before opening the lid. The volute housing/strainer pot should be cool to the touch before opening. Danger of burn if opened when hot.

---

### Seals and Bearings:

Pump seals and bearings experience normal wear and degrade over time. It is recommended to change pump seals every three (3) to four (4) years for fresh water applications and every year for salt water applications. The frequency of replacement will be determinate upon environment and water quality. If leakage is noticed at anytime, check troubleshooting tips and contact us for parts and advice. If the pump becomes abnormally noisy, this could be a sign that the bearings are failing and need replacement. There are a few options for repair when this occurs.

1. Contact PerformancePro Pumps to obtain a return authorization and ship the pump to us for repair.
2. Contact PerformancePro Pumps for a list of authorized motor repair centers near you. Note that this option may not honor any warranty but may provide a good alternative.
3. If you are mechanically minded, the option to order bearings and a seal kit from PerformancePro Pumps or your local dealer is available to perform the repair.

For questions or support contact:

Parts and Service Dept. Ph: (503) 356-5888 E: [techhelp@performancepropumps.com](mailto:techhelp@performancepropumps.com)

## Pump Disassembly

All moving parts are located in the rear sub-assembly of this pump.

Tools required:

1. 3/32 inch Allen wrench
2. 7/16 inch open end wrench
3. 9/16 inch open end wrench
4. Small and large flathead screwdrivers
5. #3 Phillips screw driver

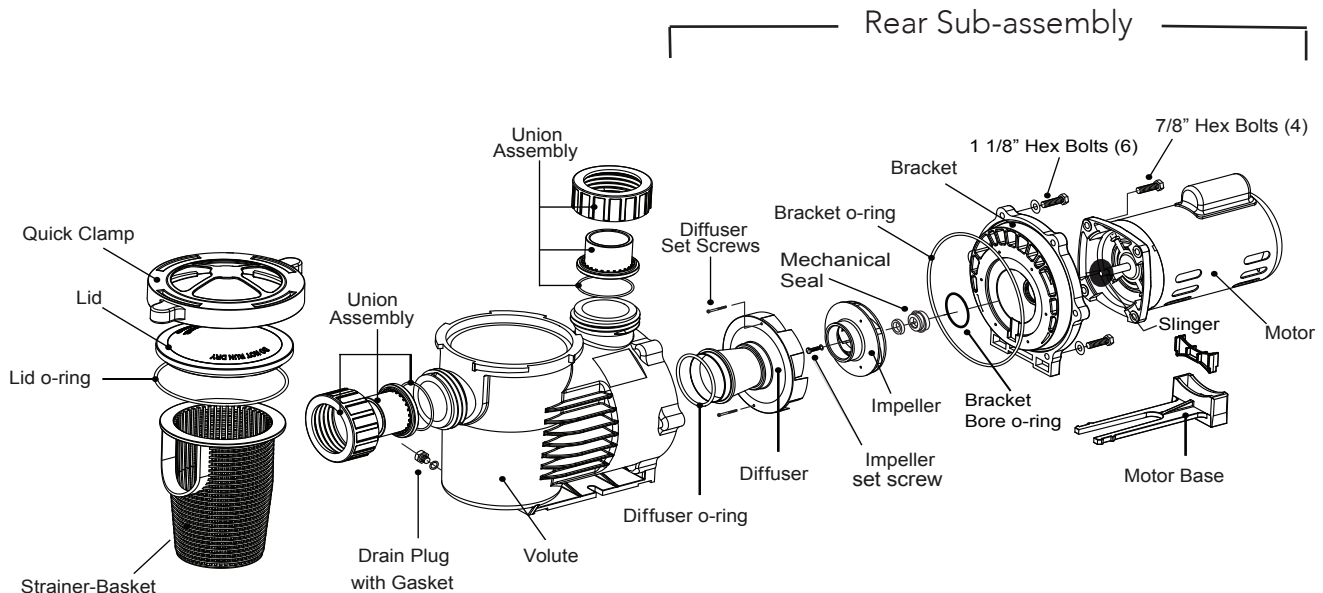

Disassembly and repair of the motor sub-assembly can be made as follows:

1. Disconnect the pump from the power source by unplugging or turn off at the circuit breaker.
2. Close all necessary valves on inlet and discharge lines and drain the pump by removing both drain plugs.
3. Loosen and remove the six (6) 1-1/8" hex bolts that hold the volute and the bracket together.
4. Pull the rear sub-assembly away from the volute. The volute may remain attached to the plumbing.
5. Loosen and remove the two (2) diffuser set screws that hold the diffuser to the bracket.
6. Remove the set screw from the impeller eye, if present. To remove, hold the impeller stationary and turn the set screw clockwise to loosen (screw is left-hand threaded).
7. Hold the motor shaft stationary by removing the cap on the opposite end of the motor and inserting a screw driver in the slot or use a wrench on the flat spot on the motor shaft depending on the motor design and unscrew the impeller by turning it counter clockwise.
8. Loosen and remove the four (4) 7/8" hex-bolts that hold the bracket to the motor face.
9. To remove the shaft seal, place the bracket face down on a flat surface and press out the carbon/spring seal from the back side. Never pry it out from the front. Carefully remove the ceramic seal from the back of the impeller hub by carefully prying up with a small flathead screw driver.
10. Clean the bracket, seal bore housing and the motor shaft as necessary.



## Parts Replacement and Pump Assembly

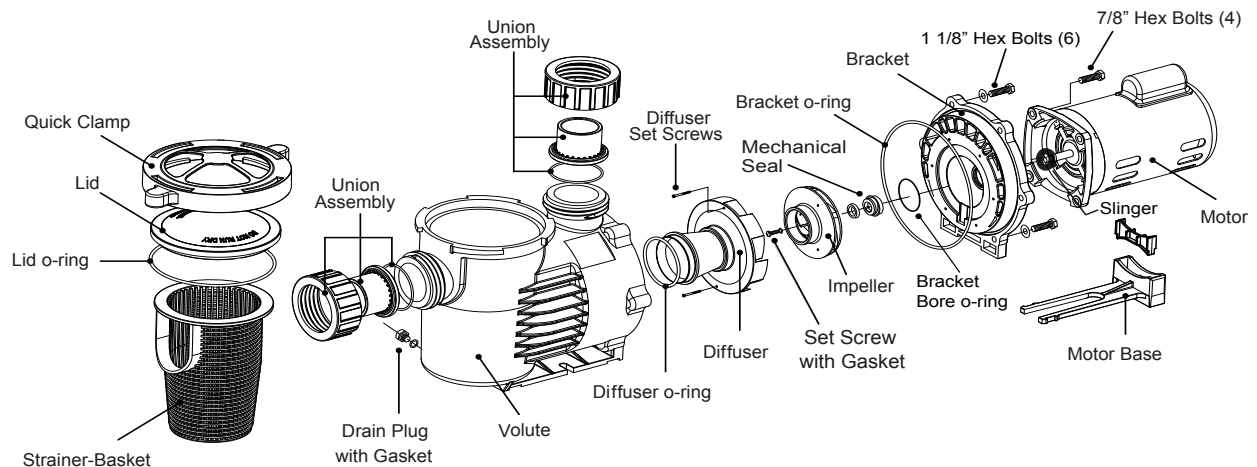

1. To install a new shaft seal, clean or replace the bracket bore o-ring. Moisten bracket bore o-ring with water prior to installing to prevent rolling.
2. Press the seal into the bore without touching or putting pressure on the delicate carbon face by pushing on the stainless steel collar. (A large socket or pipe nipple may be used to facilitate installation.)
3. Clean as necessary the impeller hub and press in the ceramic part (see tip). Make sure that it is sitting flat. The polished white ceramic face must be face out, not the rubber boot!  
Tip: Moistening the rubber boot with water prior to installation aids in proper seating.
4. Install the slinger rubber washer on the motor shaft. Install the bracket to the motor. Install and tighten the four (4) 7/8" hex bolts.
5. Screw the impeller clockwise onto the motor shaft while holding the motor shaft stationary until it makes firm contact.
6. Mount the diffuser onto the bracket fitting the plastic pins into the holes in the bracket, then tighten both diffuser set screws.
7. Make sure the diffuser o-ring and bracket gasket are clean and properly seated.
8. Assemble the motor sub-assembly to the volute using the six (6) 1-1/8" hex bolts. Do not tighten until all six (6) hex bolts are in place and hand tightened, then tighten all six (6) bolts uniformly in an alternating opposing sides pattern.
9. Insert both drain plugs with o-rings installed and tighten. Install strainer basket and fill the volute/strainer pot with water.
10. Reinstall the lid and clamp ring, turning clockwise until snug.
11. Open all valves on the system, if present, and reconnect the power to start. Wait for the pump to prime. Monitor water level in the volute/basket area to ensure water is always present. If the pump has been running with no incoming water flow for more than 15 minutes, shut the system off immediately and call PerformancePro Pumps for technical assistance.



- \* Handle the mechanical seal with care to protect the polished and lapped faces of the seal from damage.
- \* DO NOT RUN THE PUMP DRY. Pump must be filled with water and sealed before it is turned on.

## Winterization

Winterizing your pump is necessary if freezing temperatures occur in your geographic area for extended periods of time. If freezing temperatures are not common but may on occasion drop below freezing, it is advised to follow winterization procedure to protect your pump.



Freezing temperatures cause water to expand and may result in damage to the pump, plumbing, and other connected components resulting in costly repairs.

Full disconnection method:

This method is best for pumps situated outside without protection of a building or vault.

1. Disconnect the pump from the power source by unplugging or turning off at the circuit breaker.  
Note: If hardwired, you may either disconnect the electrical connection (a qualified electrician should perform this) or leave the motor connected and disconnect the pump end. If you choose this option, please follow pump disassembly instructions and insulate and cover the motor for protection.
2. Close all necessary valves on inlet and discharges lines and drain the pump by removing both drain plugs. As the pump drains, the lid may be loosened to facilitate better drainage. Tip: Store drain plugs in a resealable bag and tape the bag to the pump or store in the pump basket to prevent loss.
3. Once drained, loosen the intake and discharge ports by turning the union nut counter-clockwise until loose.
4. The pump can now be removed. Be sure the pump is fully drained and lid removed before being stored. The lid may stay secured if prior to storage the lid is removed and fully dried. Store with drain plugs removed. Your pump is now ready for storage in a dry, warm location such as a garage.  
\*\*Be sure to drain the water from the plumbing on your system and related components to prevent damage.

Connected method:

This method is best for pumps situated in a vault, shed or other covered outdoor location that may be difficult to fully remove.

1. Follow steps 1, 2 and 3 above.
2. Once drained, remove and dry the lid and place over the top without latching.
3. Drain all plumbing lines on your system.
4. Insulate the pump and exposed pipes, fully covering to prevent moisture intrusion and freezing temperature exposure. Do not directly cover with plastic sheeting as this can create condensation that can result in damage.

# Troubleshooting

The following troubleshooting tips support the most common issues. For additional assistance, please contact [techhelp@performancepumps.com](mailto:techhelp@performancepumps.com) or 503-356-5888.

PROBLEM	KNOWN ISSUE	TRY THIS
Pump is not priming	No water in strainer pot	Fill strainer pot with water and close lid. Ensure plumbing valves are open.
	Low water in the strainer pot	Check basket to make sure seated correctly and reinstall lid. Check lid for cracks and lid oring for flat spots or cracking. Check intake and discharge union fittings for cracks or loose connection. Replace or tighten. Connections must be airtight.
Motor is not turning	Circuit breaker has tripped or has no power	Reset circuit breaker and/or GFCI. Check electric supply to verify power supply is present. Test a secondary location if needed. Capacitor failure. This may be tested. Call for details. Bearing seized. Rotate motor shaft by hand to test. If shaft does not freely spin, replace bearings.
Low flow	Water flow has slowed or is intermittent	Clean filter basket of debris. Check for impeller clog. See disassembly instructions or call for details. Check for leaks in volute housing, lid and union connections. Check for obstructions in plumbing and clear if found.
Motor overheating	Seems overly hot and is shutting down or shutting off and on intermittently	Possible incorrect wiring. Have an electrician test. Test breaker. Replace if needed. Increase air flow if restricted. If pump is located in direct sunlight, try providing a properly vented shade covering.
Pump is leaking	Water leaking between motor and pump housing	Replace mechanical seal and bracket o-ring. Inspect brass inserts in volute housing by checking for loose fit of the six 1 1/8" bolts. Tighten or replace.
	Water leaking at lid or union	Check lid or union nut for cracks. Replace if needed. Check lid or union orings for cracking or flat spots. Replace if needed.

# Parts

PARTS

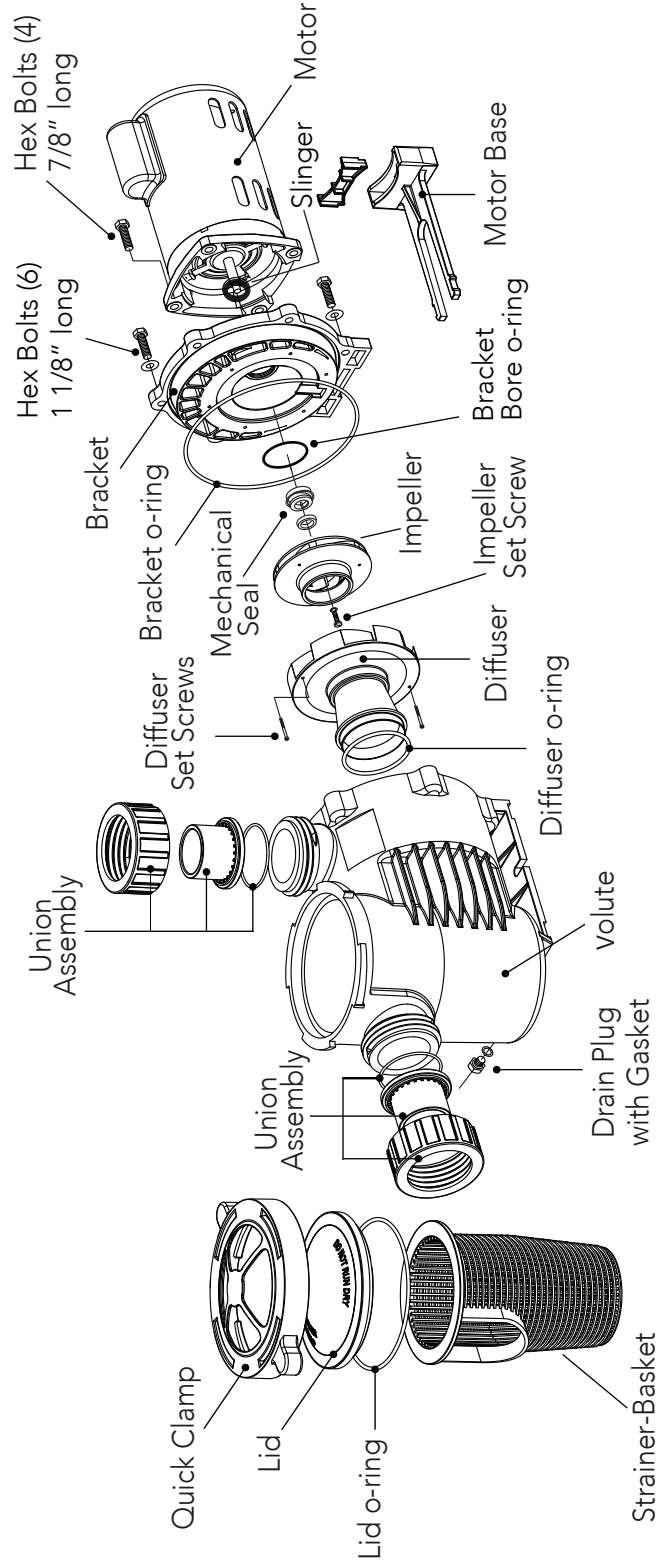

# Parts

## AP HIGH RPM PUMP SERIES PARTS

ITEM	PART NUMBER	AP1/2-HF	AP3/4-HF	AP1-HF	AP1 1/2-HF	AP2-HF	AP3-HF	AP5-HF	AP3/4-HH	AP1-HH	AP11/2-HH	AP2-HH	AP3-HH	AP5-HH
BEARINGS	BEARING-03	X		X	X	X	X	X	X	X	X	X	X	X
BRACKET	APB-3-30	X	X	X	X	X	X	X	X	X	X	X	X	X
BRACKET BORE O-RING	PBO-10	X	X	X	X	X	X	X	X	X	X	X	X	X
BRACKET O-RING	APO-3-20	X	X	X	X	X	X	X	X	X	X	X	X	X
DIFFUSER	APD-3-07	X							X	X	X	X	X	X
	APD-3-09		X	X	X	X	X	X						
DIFFUSER O-RING	APD-06	X		X	X	X	X	X	X	X	X	X	X	X
DIFFUSER SET SCREW	DSS-1	X								X	X	X	X	X
	DSS-2		X	X	X	X	X	X						
DRAIN PLUG	PPD-10	X	X	X	X	X	X	X	X	X	X	X	X	X
HARDWARE	MPH-30	X		X	X	X	X	X	X	X	X	X	X	X
IMPELLER	AP1/2L		X 3.75"											X 5.00"
	AP3/4L			X 3.80"	X 4.05"	X 4.15"	X 4.20"	X 4.45"						
	AP1L									X 4.15"				
	AP1H	X 3.60"							X 4.15"	X 4.75"				
	AP1 1/2H										X 4.85"			
	AP2H											X 4.80"		
	AP3H												X 5.00"	
IMPELLER SET SCREW	ASI-09	X	X	X	X	X	X	X	X	X	X	X	X	X
LID	ALL-3-40	X	X	X	X	X	X	X	X	X	X	X	X	X
LID O-RING	ABL-3-30	X	X	X	X	X	X	X	X	X	X	X	X	X
MOTOR BASE	APF-3-10	X	X	X	X	X	X	X	X	X	X	X	X	X
QUICK CLAMP	APC-3-50	X	X	X	X	X	X	X	X	X	X	X	X	X
SEAL - STANDARD	MPS-513	X	X	X	X	X	X	X	X	X	X	X	X	X
SALT	MPS-517	X	X	X	X	X	X	X	X	X	X	X	X	X
SEAL KIT - AP STANDARD	AP-SK1	X	X	X	X	X	X	X	X	X	X	X	X	X
AP SALT	AP-SK1-S	X	X	X	X	X	X	X	X	X	X	X	X	X
STRAINER BASKET	AAAS-3-30	X	X	X	X	X	X	X	X	X	X	X	X	X
UNION ASSEMBLY 2"	MPF-3-200	X	X	X	X	X	X	X	X	X	X	X	X	X
3"	MPF-3-300	X	X	X	X	X	X	X	X	X	X	X	X	X
VOLUTE	APV-3-10	X	X	X	X	X	X	X	X	X	X	X	X	X

PARTS

# Performance Data



## PerformancePro PUMPS

Pump Model: ArtesianPro High Flow Series  
 Impeller: Various Db: 50 - 65  
 Horsepower: 1/2 - 5 RPM: 3450  
 V: 115 / 230 ENC: ODP M: B/L Hz: 60  
 Date: 1-6-20 #704, 702, 701, 698, 705, 694, 692

- AP1/2-HF [ I: AP2H T: 3.600" Db: 50 ]
- AP3/4-HF [ I: AP1/2L T: 3.750" Db: 50 ]
- AP1-HF [ I: AP3/4L T: 3.800" Db: 55 ]
- AP11/2-HF [ I: AP3/4L T: 4.050" Db: 60 ]
- AP2-HF [ I: AP3/4L T: 4.225" Db: 60 ]
- AP3-HF [ I: AP1L T: 4.200" Db: 60 ]
- AP5-HF [ I: AP1L Tr: 4.450" Db: 65 ]

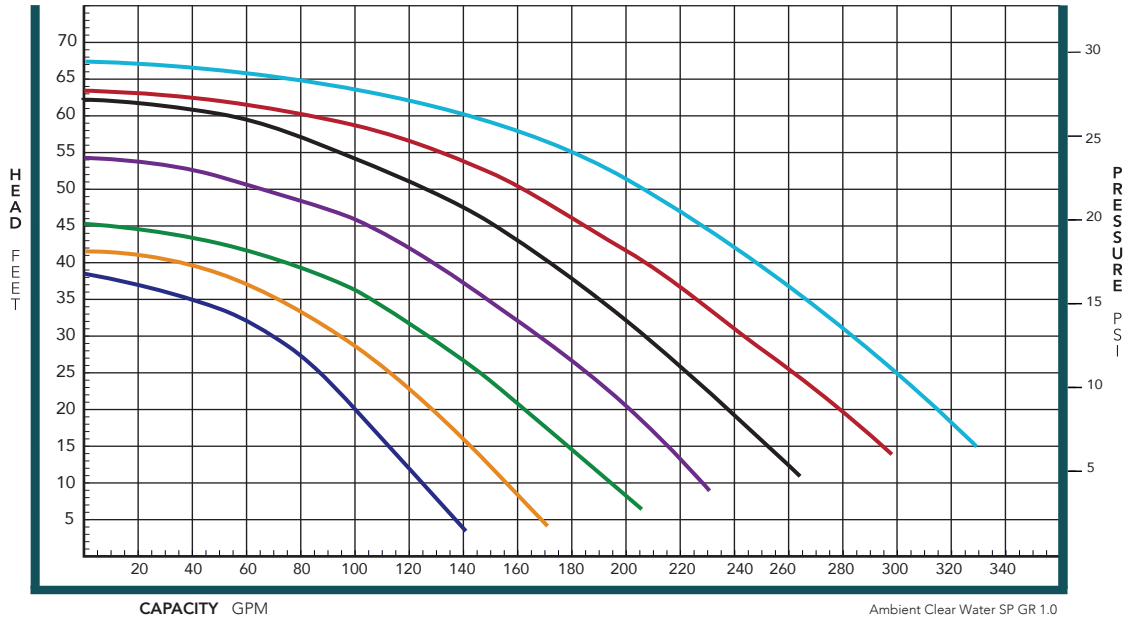

PERFORMANCE



## PerformancePro PUMPS

Pump Model: ArtesianPro High Head Series  
 Impeller: Various Db: 50 - 65  
 Horsepower: 3/4 - 5 RPM: 3450  
 V: 115 / 230 ENC: ODP M: L Hz: 60  
 Date: 1-20-20 #703, 700, 699, 712, 695, 691

- AP3/4-HH [ I: AP1H T: 4.150" Db: 50 ]
- AP11/2-HH [ I: AP1.5H T: 4.850" Db: 60 ]
- AP3-HH [ I: AP3H T: 5.00" Db: 65 ]
- AP1-HH [ I: AP1H T: 4.750" Db: 55 ]
- AP2-HH [ I: AP2H T: 4.850" Db: 55 ]
- AP5-HH [ I: AP1/2L T: 5.00" Db: 65 ]

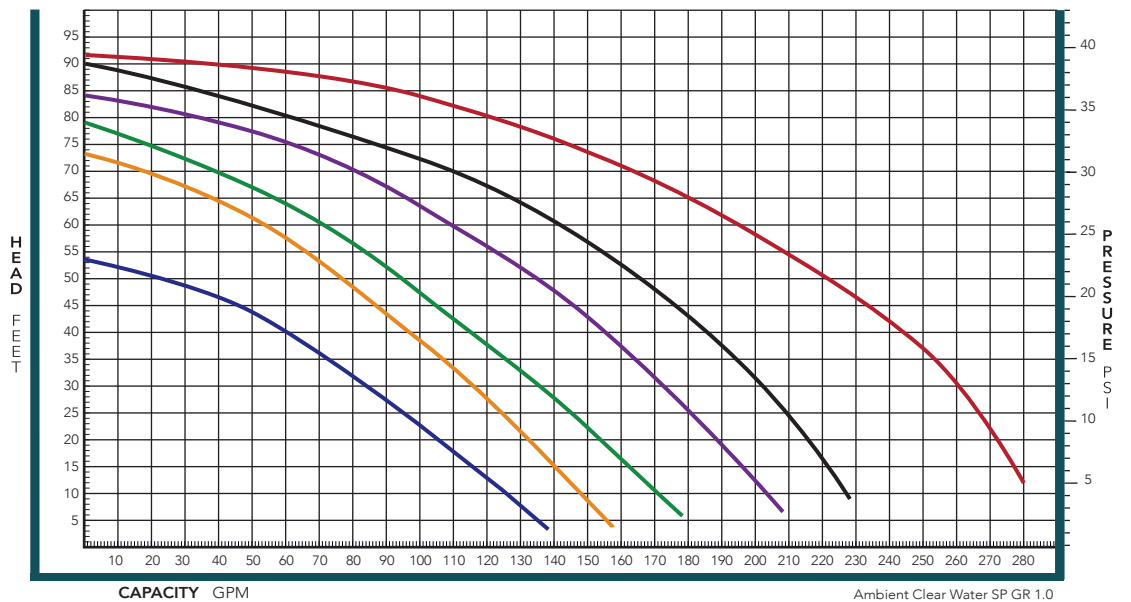

# Warranty

## PerformancePro Pumps Limited Warranty ArtesianPro Series

This ArtesianPro series product is warranted to the Purchaser (defined herein as the original end user) to be free of defects in construction and workmanship at the time of purchase. In the event this product malfunctions within three years (for fresh water use) or one year (for use with salt water or other suitable fluids) from the date of purchase the sole obligation of PerformancePro Pumps will be to replace or make this product capable of being operated according to the original product description without charges for labor parts to the Purchaser, and are subject to the following conditions:

1. The malfunction is proved attributable to a defect in construction or workmanship, including repairs performed under this warranty. Malfunction for any other reason - including but not limited to misuse, abuse, negligence, accident, corrosion or salt build up, incorrect wiring or electrical supply, tampering with parts, or improper installation- will not be remedied under this warranty. Problems or damage from failure to comply with instructions in the owner's manual, improper plumbing and positioning, flooding, incompatibility with fluid chemistry and running the unit dry are not covered under this warranty.
2. PerformancePro Pumps must perform all warranty repairs. Purchaser must retain the purchase receipt and present it with this certificate as proof of ownership and entitlement to warranty repairs. The cost of unauthorized repairs will not be reimbursed to Purchaser by PerformancePro Pumps, and are not the responsibility of PerformancePro Pumps. If repairs by Purchaser or a third party damage the product, such damage is not remediable under this warranty.
3. Purchaser shall bear all shipping, packing, and insurance costs and all other costs, excluding labor and parts necessary to effectuate the repairs under this warranty. Purchaser will pay for return freight.
4. For applications that involve fluids other than water, the Purchaser shall retain and present to PerformancePro Pumps evidence of purchaser's compatibility tests under actual operating conditions. Any problems caused by a chemical incompatibility of the fluid with the pump materials, are expressly not covered by this warranty.
5. Periodic check-ups and/or maintenance are not covered by this warranty.
6. For all sales in the State of Oregon this is the sole and exclusive manufacturer's warranty. There are no warranties which extend beyond the warranty set forth herein, and in accord with Oregon Revised Statutes ORS 72.3160 any and all implied warranties, including any warranties of merchantability and fitness for particular purpose, are disclaimed and excluded. Some States do not allow disclaimers/exclusions of, or limitations on how long an implied warranty lasts, so in such States, and except as is otherwise provided by applicable law of said States, no action on a warranty implied at law shall be commenced more than one year following the date of purchase. No action shall be brought for breach of any express warranty subsequent to the expiration of the express written warranty.
7. Incidental and consequential damages (specifically including, but not limited to, damages for loss of profits or damages relating to down time of personnel, equipment, or facilities) caused by malfunction, defect, or otherwise, whether alleged to be the result of breach of any express or implied warranty, or the negligence, willful misconduct or other act of PerformancePro Pumps are not the responsibility of PerformancePro Pumps, and to the extent permitted by law, are hereby excluded, including, but not limited to property damage, and to the extent not prohibited by applicable law, personal injury or death and Purchaser hereby agrees to expressly waive any claim for all such damages. If a final determination is made in a court of competent jurisdiction that any one or more of the damages which are disclaimed, excluded and/or waived under this paragraph are not allowed under public policy or applicable law, then the disclaimer, exclusion and waiver of all of the other damages not prohibited by public policy or applicable law shall continue to apply.
8. This warranty does not apply to any malfunction arising out of any application of this product other than in a use compatible with the manufacturer's product description, unless such application is, upon request, specifically approved in writing by PerformancePro Pumps.
9. The provisions of this warranty are severable and if any provision shall be deemed invalid, the remaining provisions shall remain in full force and effect.
10. This limited warranty extends only to the original Purchaser (end user) and does not extend to transferee or purchaser from the original Purchaser. Any purported assignment without the consent of PerformancePro Pumps shall be null and void.
11. No warranty whatsoever of chemical compatibility or application suitability is given. It is the sole responsibility of the Purchaser to determine if the merchandise purchased is suitable for Purchaser's specific application. PerformancePro Pumps strongly advises that the customer perform any and all tests necessary to determine material compatibility and product suitability for customer's specific conditions and needs.
12. This contract shall be governed by and in accordance with the laws of the State of Oregon. Purchaser agrees that proper jurisdiction and venue for any claim brought hereunder is in Washington County, Oregon.
13. This limited warranty is incorporated by reference into the contract of purchase for the products supplied by PerformancePro Pumps to Purchaser under said contract.

WARRANTY

# PROTECT YOUR INVESTMENT!

---

Exposure to the elements can result in corrosion  
and reduced service life of your pump.  
Protect your pump motor from the elements today!

- \* Excellent weather protection
- \* Sturdy construction
- \* Noise abatement
- \* Customizable precut knockout sections
- \* Easy to assemble
- \* Fits Artesian, Artesian 2, ArtesianPro and Cascade series

Part #:  
MPC-10



## ***PerformancePro***

PROUDLY BUILT IN THE USA SINCE 2000 **PUMPS**